

AtriCure®

® cryoICE BOX



Version 6 USER'S MANUAL

AtriCure cryoICE BOX, model ACM1 – 115 (100-120)VAC, 4A, 50/60 Hz

AtriCure cryoICE BOX, model ACM2 – 230 (220-240)VAC, 2A, 50/60 Hz

Rx ONLY



European Representative:
AtriCure Europe B.V.
De entree 260
1101 EE Amsterdam
NL
+31 20 7005560
ear@atricure.com



Manufacturer:
AtriCure, Inc.
7555 Innovation Way,
Mason, Ohio 45040 USA
+1 866 349 2342 (toll free)
+1 513 755 4100 (phone)

2023-11 | P001323.G | en

CE
2797

TABLE OF CONTENTS

FOREWORD	IV
CAUTION	IV
IMPORTANT	IV
INDICATIONS FOR USE/INTENDED PURPOSE	IV
PATENT INFORMATION	IV
WARNINGS AND CAUTIONS	IV
WARNINGS.....	V
CAUTIONS.....	V
Meanings of Symbols on AtriCure cryoICE BOX.....	VI
Classification in accordance with IEC, EN, ANSI/AAMI, CSA 60601-1.....	VII
1. SYSTEM OVERVIEW	1
The AtriCure cryoICE BOX.....	1
AtriCure cryoICE BOX Front and Rear Panels – Illustrations and Nomenclature.....	1
Operating Modes.....	2
READY Mode.....	2
FREEZE Mode.....	2
DEFROST Mode.....	2
FAULT Condition.....	2
2. TECHNICAL SPECIFICATIONS	2
Mechanical Specifications.....	2
Electrical Specifications.....	3
Mains Fuses.....	3
Footswitch Specifications.....	3
Equipment Type / Classification.....	3
3. ATRICURE CRYOICE BOX, DETACHABLES, AND ACCESSORIES	3
AtriCure cryoICE BOX Set-Up and Preparation.....	4
N ₂ O Cylinder Installation.....	4
Exhaust Tubing.....	5
Heater Band Installation.....	5
Turning On the AtriCure cryoICE BOX.....	6
Resetting the N ₂ O Gas Gauge.....	6
System Check.....	7
4. DEVICE USE	7
Install AtriCure cryoICE Probe.....	7

Set Ablation Time	9
Start Ablation	9
5. SPECIAL CASES	9
Abort FREEZE.....	9
Change Ablation Time during Ablation	9
Emergency Stop	9
Set Default Ablation Time	9
Operate Without Temperature Reading	10
6. SYSTEM DISASSEMBLY AFTER USE	10
Disconnecting the AtriCure cryoICE Probe	10
N ₂ O Cylinder Removal.....	10
7. PREVENTIVE MAINTENANCE AND CLEANING OF THE ATRICURE CRYOICE BOX	10
Cleaning and Disinfecting Instructions	10
Preventive Maintenance	11
AtriCure Address / Toll Free Telephone Number	11
Corporate Website	11
Customer Service/ Product Inquiries.....	11
Replacement of AC Line Fuses.....	11
Procedure to Replace AC Mains Fuses	12
Tank Hose Assembly without canisters – Standard	12
Tank Hose Assembly with canisters – Alternate (Replacement of Desiccant Filter)	13
Table 1 – Region Specific Vacuum/WAGD Connectors.....	15
Other Detachable and Accessory Devices.....	15
Disposal	15
8. TROUBLESHOOTING	16
AtriCure cryoICE BOX Error Codes	18
9. ELECTROMAGNETIC COMPATABILITY TABLES	19
Electromagnetic Emissions.....	19
Electromagnetic Immunity – Enclosure Port	19
Electromagnetic Immunity – Input A.C. Power Port	20
Electromagnetic Immunity – Input D.C. Power Port – Not Applicable	22
Electromagnetic Immunity – Patient Coupling Port.....	22
WARRANTIES	23
DISCLAIMER	23

FOREWORD

This manual and the equipment it describes are for use only by qualified medical professionals trained in the particular technique and surgical procedure to be performed. The AtriCure *cryoICE* BOX also referred to as the AtriCure Cryo Module (ACM) consisting of two model units: ACM1 and ACM2.



CAUTION

Federal (US) law restricts this device to sale by or on the order of a physician.

Please read all information carefully. Failure to properly follow the instructions may lead to serious surgical consequences including patient and caregiver harm.

IMPORTANT

This user manual is designed to provide instructions for use of the AtriCure *cryoICE* BOX (A000896-3 & A000897-3 assembly/A000898-3 & A000899-3 packaged assembly) with the AtriCure *cryoICE* probes and AtriCure Detachable and Accessory Devices (See page 22 of this manual for specific part numbers information.) This user manual is not a reference to surgical technique.

INDICATIONS FOR USE/INTENDED PURPOSE

The AtriCure *cryoICE* BOX is a non-sterile, reusable device which delivers cryogenic energy, namely nitrous oxide, to AtriCure's cryo-ablation probes.

The intended purpose of the ACM Exhaust Hose Connector is an optional accessory of the AtriCure *cryoICE* BOX, providing a method to connect the AtriCure *cryoICE* BOX exhaust to a hospital medical vacuum or waste anesthesia gas disposal (WAGD) system. It is intended only to be used together with the AtriCure *cryoICE* BOX to enable meeting its intended purpose.

The ACM footswitch is used to activate the AtriCure *cryoICE* BOX as an alternative to using the Activation Button on the front panel of the generator.

The AtriCure *cryoICE* BOX unit is an electro-mechanical cryogenic surgical unit that delivers a cryogenic Nitrous Oxide (N_2O) energy source to a *cryoICE* probe to create lines of ablation through tissue. The AtriCure *cryoICE* BOX is part of a system which includes the N_2O gas cylinder, N_2O gas line hose, N_2O exhaust hose, cylinder heater band, an optional footswitch, and single-use *cryoICE* probes. The system provides controlled lesion forming temperatures below $-40^{\circ}C$, with typical operating ranges between $-50^{\circ}C$ to $-70^{\circ}C$.

The AtriCure *cryoICE* BOX is designed to operate only with AtriCure designed and developed *cryoICE* probes. The AtriCure *cryoICE* probe will be referred in this User's Manual as the "*cryoICE* probe".

This User's Manual provides a description of the AtriCure *cryoICE* BOX, its controls, displays, indicators, and a sequence for its operation with the *cryoICE* probe. This User's Manual also supplies other information of importance to the user. For information about the *cryoICE* probes, please refer to the *cryoICE* probe Instructions for Use.

Do not operate the AtriCure *cryoICE* BOX before thoroughly reading this manual.

PATENT INFORMATION

May be covered by one or more patents.

WARNINGS AND CAUTIONS

The safe and effective use of the cryo device and equipment is highly dependent upon factors under the control of the operator. There is no substitute for a properly trained operating room staff. It is important that the operating instructions supplied with the AtriCure *cryoICE* BOX unit be read, understood, and followed before use.



WARNINGS





































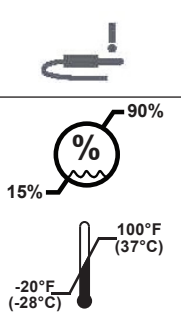

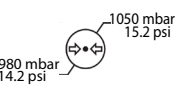
- Do not operate the *cryoICE* BOX unit before thoroughly reading this manual.
- Do not use cryo surgical equipment unless properly trained in the specific procedure being undertaken. This manual and the equipment it describes are for use only by qualified medical professionals trained in the particular technique and surgical procedure to be performed.
- **Fire Hazard:** Do not use extension cords.
- **Trip Hazard:** Standard care should be used to reduce the risk of tripping on the Footswitch cable, as well as the N₂O exhaust hose.
- No modification of this equipment is allowed.
- The voltage selector is factory set and should not be changed by the user. The voltage setting and the fuse rating must be appropriate as identified to prevent *cryoICE* BOX malfunction and potential instrument damage.
- **Electric Shock Hazard:** Connect the *cryoICE* BOX power cord to a properly grounded receptacle. Do not use power plug adapters.
- **Electric Shock Hazard:** Do not connect wet accessories to the generator.
- **Electric Shock Hazard:** Ensure that the *cryoICE* probe is correctly connected to the *cryoICE* BOX and that no thermocouple wires are exposed from the cable, connector, or the *cryoICE* probe.
- Use of accessories, transducers and cables other than those specified or provided by AtriCure could result in increased electromagnetic emissions or decreased electromagnetic immunity of the *cryoICE* BOX and result in improper operation
- Use of the *cryoICE* BOX adjacent to or stacked with other equipment should be avoided because it could result in improper operation
- Portable RF communications equipment (including peripherals such as antenna cables and external antennas) should be used no closer than 30 cm (12 inches) to any part of the *cryoICE* BOX, including cables specified by the AtriCure. Otherwise, degradation of the performance of this equipment could result.
- The Emissions characteristics of this equipment make it suitable for use in industrial areas and hospitals (CISPR 11 class A). If it is used in a residential environment (for which CISPR 11 class B is normally required) this equipment might not offer adequate protection to radio-frequency communication services. The user might need to take mitigation measures, such as relocating or reorienting the equipment.
- The ACM Exhaust Hose connector requires a dedicated Vacuum or WAGD port to prevent back pressure into the patient's breathing line, which may result in Pneumothorax.



CAUTIONS

- Use only with the *cryoICE* probes intended for use with the *cryoICE* BOX.
- Do not transition into FREEZE mode until the *cryoICE* probe is properly positioned at the ablation site.
- The system status indicators and displays are important safety features. Do not obstruct either the ablation or the system status indicators.
- Do not remove the *cryoICE* BOX cover as there is a potential for electrical shock. Refer to authorized personnel for service.
- The Power Cord of the *cryoICE* BOX must be connected to a properly grounded receptacle. Extension cords and/or adapter plugs must not be used.
- Do not contact *cryoICE* probes with a RF device.
- **Compressed Air Hazard:** Do not operate N₂O cylinders with a pressure greater than 1000 PSIG (6900 kPa).
- Nitrous Oxide connections should only be unplugged when the *cryoICE* BOX is in the READY mode and properly vented.

Meanings of Symbols on AtriCure cryoICE BOX

Power Off		Cylinder Valve On/Off	
Caution		N ₂ O Gas Gauge Reset	
Alternating Current		Gas Exhaust	
Equipotential Terminal		Maintenance Needed	
Type CF Applied Part (cryoICE Probe)		Cylinder Heater Band	
READY		Footswitch	
FREEZE		Maximum Pressure	
DEFROST		Gas Inlet	
N ₂ O Gas Gauge		Gas Outlet	
Timer		Non-Sterile	
Timer Increase Button		Manufacturer	
Timer Decrease Button		Catalog Number	
cryoICE Probe Temperature		Serial Number	
Thermocouple/Probe		Caution: Federal Law (US) restricts this device to sale by or on the order of a physician	Rx ONLY
Humidity and Temperature Storage, Transit, and Operational Limits		Conforms to the requirements of the European Directives and Regulations	
Operational & Storage Pressure Limits		Follow Instructions for Use	
Medical Device		Consult Instructions for Use	
Contains hazardous substances		Waste Electrical and Electronic Equipment (WEEE)	
Date of Manufacture		Model Number	
Not made with dry natural rubber or natural rubber latex		Does not contain phthalates	

SAFETY INFORMATION



E509985

**MEDICAL — GENERAL MEDICAL EQUIPMENT
AS TO ELECTRICAL SHOCK, FIRE AND MECHANICAL HAZARDS ONLY
IN ACCORDANCE WITH ANSI/AAMI ES60601-1 (2005) + AMD 1 (2012)
CAN/CSA C22.2 No. 60601-1 (2014) E509985**

Cryogenic Ablation Device, Model AtriCure Cryo Module, ACM1 & ACM2, cord connected/ appliance coupler /
transportable, rated: 115/230Vac, 4/2A, 50/60 Hz

1. Type of protection against electric shock: Class I
2. Degree of protection against electric shock: Type CF
3. Degree of protection against ingress of water: IPX0
4. Equipment not suitable for use in the presence of a flammable anesthetic mixture with air or with oxygen or nitrous oxide
5. Mode of operation: Continuous
6. Environmental Conditions: Normal: 10-40°C (50°F-104°F), 15-90% rH, 980-1050mb

1. SYSTEM OVERVIEW

The AtriCure cryoICE BOX

This section provides a detailed description of the cryoICE BOX including its function and operating features.

- The cryoICE BOX unit is an electro-mechanical cryogenic surgical unit that delivers a Nitrous Oxide (N₂O) cryogenic energy source to a cryoICE probe to create lines of ablation through tissue. The cryoICE BOX is part of a system which includes the N₂O cylinder, N₂O gas line hose, N₂O exhaust hose, cylinder heater band, an optional footswitch, and single-use cryoICE probes. The system provides controlled lesion forming temperature that is below -40°C, with typical operating ranges between -50°C to -70°C.
- Along with the Activation Button on the front panel of the cryoICE BOX, an optional Footswitch can also be used to activate and terminate the cryo ablation cycle.
- The cryoICE BOX is designed to operate only with AtriCure cryoICE probes. Refer to the cryoICE probe Instruction for Use for complete description and indications for use of these devices.

AtriCure cryoICE BOX Front and Rear Panels – Illustrations and Nomenclature

Illustrations of the cryoICE BOX front panel (Figure 1) and rear panel (Figure 2) are shown below.

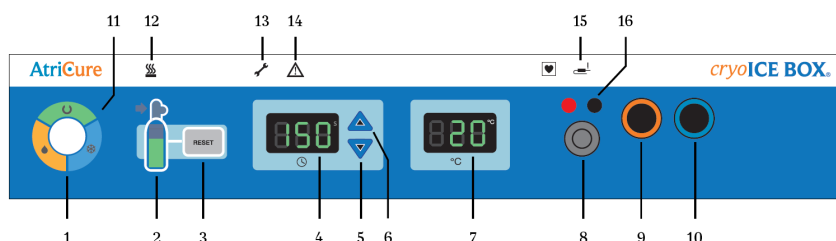
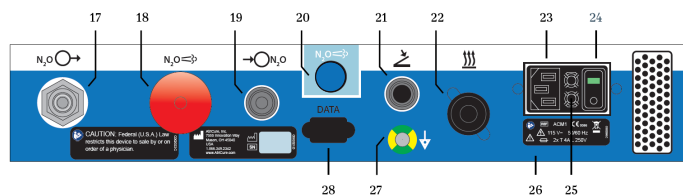
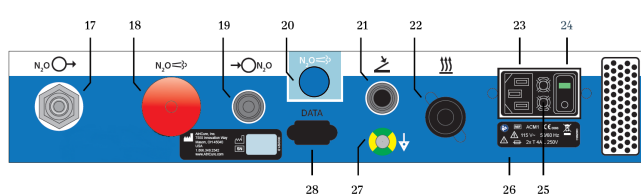

Figure 1: AtriCure cryoICE BOX Front Panel

- | | |
|---|--------------------------------------|
| 1. Activation Button | 9. cryoICE Probe Gas Outlet Port |
| 2. N ₂ O Gas Gauge Indicator Display | 10. cryoICE Probe Gas Inlet Port |
| 3. N ₂ O Gas Gauge Indicator Display Reset | 11. Ablation Status Indicator |
| 4. Ablation Timer Display | 12. Cylinder Heater Band Indicator |
| 5. Ablation Timer Decrement | 13. Maintenance Needed Indicator |
| 6. Ablation Timer Increment | 14. System Fault Indicator |
| 7. cryoICE Probe Temperature | 15. Thermocouple Open Indicator |
| 8. Future Probe Connection | 16. cryoICE Probe Thermocouple Ports |



Domestic



International

Figure 2: AtriCure cryoICE BOX Rear Panel

- | | |
|---|--------------------------------------|
| 17. N ₂ O Exhaust Port | 23. Power Plug Receptacle |
| 18. N ₂ O Manual Exhaust Knob | 24. Power Switch |
| 19. N ₂ O Inlet Port | 25. Mains Fuse Location |
| 20. N ₂ O Exhaust Switch | 26. cryoICE BOX Voltage Rating Label |
| 21. Activation Footswitch Connection Port | 27. Equipotential Terminal |
| 22. Heater Band Cord Receptacle | 28. RS232 Data Connection |

Operating Modes

The *cryolICE* BOX operates in one of three modes: READY, FREEZE, and DEFROST. These modes are identified by the system status indicator LEDs and the ablation status indicator LEDs located on the front of the *cryolICE* BOX unit.

READY Mode

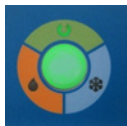

This mode is entered automatically upon successful execution of Power-on-self -test when the unit is first turned on or following DEFROST Mode upon the *cryolICE* probe reaching approximately 10°C and automatically venting. This indicates that the system is ready for the next cryo ablation run.

FREEZE Mode

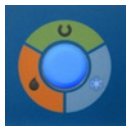

This Mode is entered from the READY Mode when the user initiates the cryo ablation cycle by pressing and releasing the Activation Switch or the Footswitch. In this mode, the N₂O gas is allowed to cycle through the *cryolICE* probe causing a temperature drop to take place at the *cryolICE* probe.

DEFROST Mode

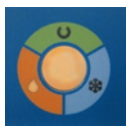

This Mode is entered automatically from FREEZE Mode upon expiration of the ablation timer, or manually by the operator when the Activation Switch or the Footswitch is actuated while in the FREEZE Mode. In this mode, the *cryolICE* probe temperature is actively forced towards the ambient temperature.

Once the *cryolICE* probe temperature is above approximately 10°C, the *cryolICE* BOX unit will transition back to the READY Mode.

Note: *cryolICE* BOX does allow early transition out from the DEFROST Mode into either the READY Mode or the FREEZE Mode by pressing the Activation Button.

Note: *cryolICE* probe temperature may drop temporarily upon transition from DEFROST to READY state.

FAULT Condition



This is entered upon detection of any unrecoverable error condition during any Mode. The system is inoperable in this Mode until the unit is first power cycled, and only if the fault condition no longer exists or has been remedied.

2. TECHNICAL SPECIFICATIONS

Mechanical Specifications

Size: 17.5 in (44.5 cm) - (W) × 27.0 in (68.6 cm) - (D) × 4.5 in (11.4 cm) - (H) maximum

Weight: 45 lb. (20.4 kg) absolute maximum

Environmental Specifications

	Temperature	Humidity	Atmospheric pressure
Operational Temperature	+10°C to +40°C +50°F to +104°F	15% to 90% relative humidity	980mb to 1050mb 14.2psi to 15.2psi
Storage	-28°C to +37°C -20°F to +100°F	15% to 90% relative humidity	980mb to 1050mb 14.2psi to 15.2psi
Transit	-28°C to +37°C -20°F to +100°F	30% to 85% relative humidity	

Electrical Specifications

AtriCure cryoICE BOX, model ACM1 – 115 (100-120)VAC, 4A, 50/60 Hz

AtriCure cryoICE BOX, model ACM2 – 230 (220-240)VAC, 2A, 50/60 Hz

Mains Fuses

AtriCure cryoICE BOX, model ACM1 – 115 (100-120)VAC, 4A, 50/60 Hz

Replace fuses as marked: 4.0A/250V, T-lag, 5 × 20 mm, UL Recognized, IEC Approved

AtriCure cryoICE BOX, model ACM2 – 230 (220-240)VAC, 2A, 50/60 Hz

Replace fuses as marked: 2.0A/250V, T-lag, 5 × 20 mm, UL Recognized, IEC Approved

cryoICE Probe Temperature Display Accuracy (see figure 1 item 7)

Resolution: 1°C (increments)

Temperature > or = -40°C Accuracy of +3°C/-6°C

Temperatures < -40°C Accuracy of +5°C/-8°C

Footswitch Specifications

Moisture protection rating: IP68

Equipment Type / Classification

Class 1 Equipment

3. AtriCure cryoICE BOX, DETACHABLES, AND ACCESSORIES

As shown in Figure 3, the system is comprised of the following:

A: AtriCure cryoICE BOX Cylinder Heater Band (CMH15 or CMH22) - Detachable

B: AtriCure cryoICE BOX Tank Hose Assembly, without Canister Set, Standard - Detachable

C: AtriCure cryoICE BOX N₂O Exhaust Hose - Detachable

D: AtriCure cryoICE BOX Exhaust Hose Connector - Detachable

E: AtriCure cryoICE BOX Tank Hose Assembly, with Filter Canister Set (Optional) - Detachable

F: AtriCure cryoICE BOX

G: AtriCure cryoICE BOX Footswitch (Optional – not shown) - Accessory

H: AtriCure cryoICE BOX Power Cord (not shown) - Detachable

I: AtriCure cryoICE probe with integral tube set (not shown) - Type CF Applied Part

J: AtriCure cryoICE BOX Heater Band Extension Spring (not shown) – Detachable

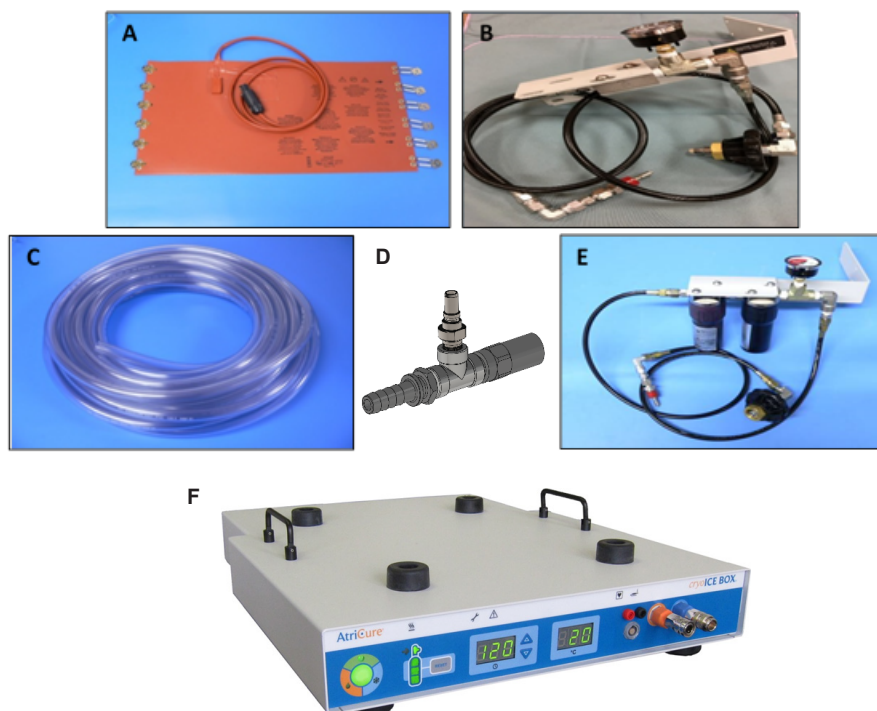

Figure 3: AtriCure cryoICE BOX, Detachables, and Accessories

AtriCure cryoICE BOX Set-Up and Preparation

This section will outline the preliminary set-up for the *cryoICE* BOX, including cylinder installation, heater band installation, turning on the *cryoICE* BOX, and resetting the cylinder gauge on the *cryoICE* BOX user interface.

Note: The *cryoICE* BOX should be set up at least 15-minutes prior to the procedure to allow time for the heater to warm the N₂O cylinder to operating temperature.

N₂O Cylinder Installation

- Use only nitrous oxide gas with a water content not exceeding 3 ppm. Automotive grade nitrous oxide should not be used due to the inclusion of hydrogen sulfide.
- The *cryoICE* BOX is designed to use 20-pound (9-kg.) cylinders.
- Always install a completely full cylinder so the cylinder volume can be indicated correctly.
- To install a new N₂O cylinder, first find the N₂O gas line receptacle on the rear panel and connect this end into the corresponding end of the N₂O gas line. Insert and push in the connector until you hear it “click” in place and the connection is fully seated and secured from unlatching as seen below in Figure 4.



Figure 4: N₂O Inlet Connection

- Next, match the opposite black knob end of the N₂O gas line with the threaded connection port of a new N₂O gas cylinder.
- Screw the *cryoICE* BOX gas line into place by hand tightening the knob as shown in Figure 5. Over tightening this fitting with a wrench may cause damage, allowing N₂O gas to leak.
- To open gas cylinder valve, slowly turn the knob on the top of the cylinder counter-clockwise as seen in Figure 6.



Figure 5: Attach Black Knob to Threaded Connection



Figure 6: Turn Valve Counter-Clockwise to Open

- Listen for leaks. If a leak is detected, tighten the black knob with a wrench if needed.
- If the Low-Pressure indicator, as seen in Figure 7, illuminates amber this indicates that the cryoICE BOX is not detecting proper pressure. Check to ensure that the gas cylinder valve is open fully and that the cylinder you have attached is not empty.



Figure 7: Low Pressure Indicator

Exhaust Tubing

Note: Ensure the Exhaust tubing (hose) is firmly attached to the cryoICE BOX N₂O exhaust port, see Figure 2 item 17.

- Be sure to route the N₂O vent tubing to a safe area prior to use.
- If a scavenger system is used, it must be able to accommodate a continuous flow of 60-liters per minute.

Heater Band Installation

- Ensure the cryoICE BOX is properly connected to an N₂O gas cylinder.
- Place heater band with the cord facing upward.
- Secure all tensioning spring retainers around the gas cylinder, starting with the very bottom and very top retainers and then proceed to secure the middle retainers as shown in Figure 8.
- The Heater band must be positioned less than 2-inches (5-cm) from bottom of the cylinder to ensure that the N₂O is heated efficiently.
- Plug heater band cord into the appropriate indicated receptacle located on the rear panel of the cryoICE BOX unit as shown in Figure 9.
- Verify that the Cylinder Heater Band Icon on the front of the unit is not illuminated.



Figure 8: Secure All Tensioning Spring Retainers



Figure 9: Plug Heater Band Cord into Receptacle

Turning On the AtriCure cryoICE BOX

- Plug in the cryoICE BOX unit into an approved hospital outlet.
- Turn-On the cryoICE BOX unit with the switch located on the back as seen in Figure 10. The power switch is used to connect mains power (Turn-On) or disconnect mains power (Turn-Off) to the cryoICE BOX unit.
- After powering up, the Activation Button on the front of the cryoICE BOX interface will be illuminated. If no light is observed, check for proper power cord connection and switch position

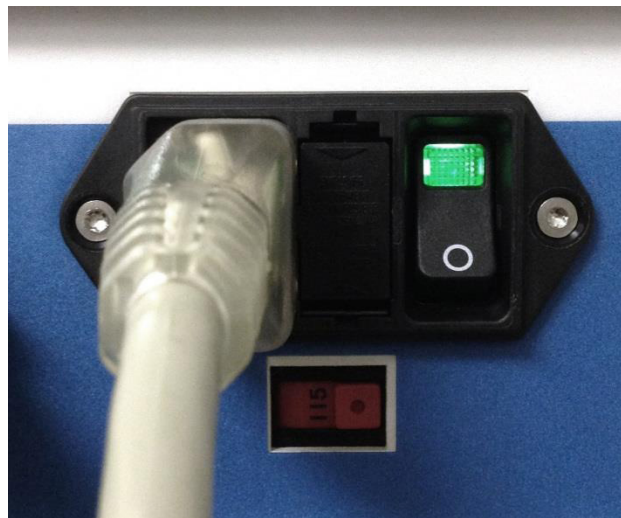

Figure 10: Turn-On AtriCure cryoICE BOX with Switch

Resetting the N₂O Gas Gauge

- Only reset the gauge when a new full cylinder has been installed.
- Ensure cryoICE BOX is powered on.
- Ensure the unit is in READY mode.
- Find the gas cylinder display on the front of the cryoICE BOX and note the RESET button to the right of this display, see Figure 11.
- Press and hold the RESET button for one second.

Note: Once the N₂O gas gauge is reset, the display can take up to several minutes to display the remaining volume in the tank.

- The gauge can only be reset to full after a system power cycle or following a cylinder swap out. If RESET button is pressed following usage the gauge will reset to the estimated cylinder volume.

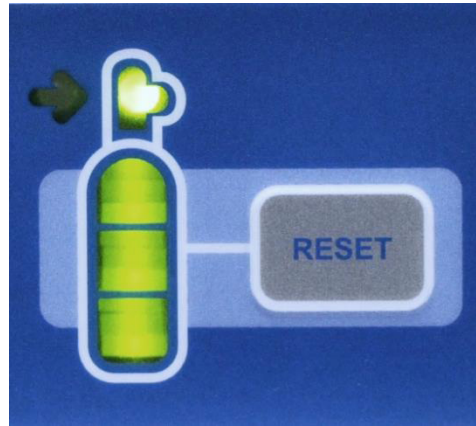

Figure 11: N₂O Gas Gauge RESET Button

- Meaning of gas gauge indicators seen in Figure 12

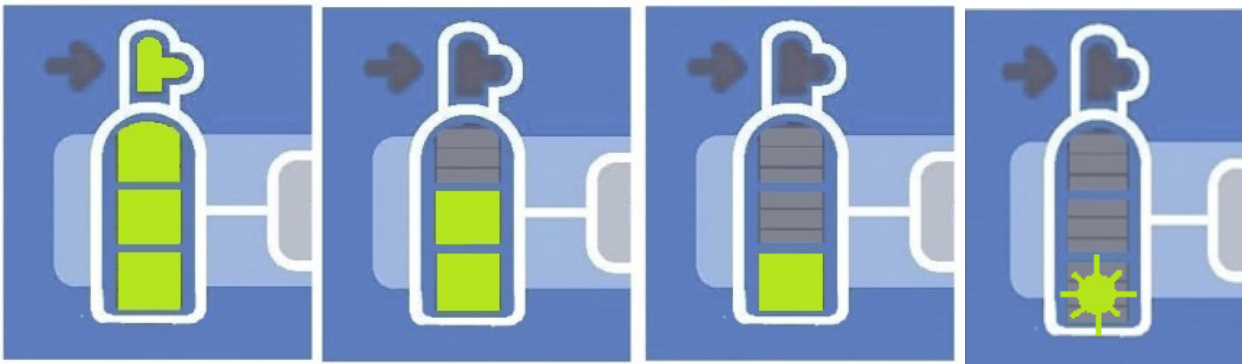

Figure 12: N₂O Gauge Indicators

3-Segments On = Approximately 20-40 minutes remaining

2-Segments On = Approximately 15-20 minutes remaining

1-Segment On = Approximately 5-10 minutes remaining

1-Segment Flashing = Approximately 5 minutes or less remaining – **CHANGE TANK**

System Check

- Verify neither the Maintenance Needed or System Fault icons are illuminated.

4. DEVICE USE

Install AtriCure cryoICE Probe

1. Ensure cryoICE BOX is properly connected to a N₂O gas cylinder.
2. The cryoICE probe may be connected before the cryoICE BOX has been turned on, while the cryoICE BOX is being turned on, or when the cryoICE BOX unit is on and in READY mode.
3. Insert the corresponding connections on the pneumatic connectors as shown below in Figure 13. The sliding ring will need to be manually pushed-in on the orange connector.

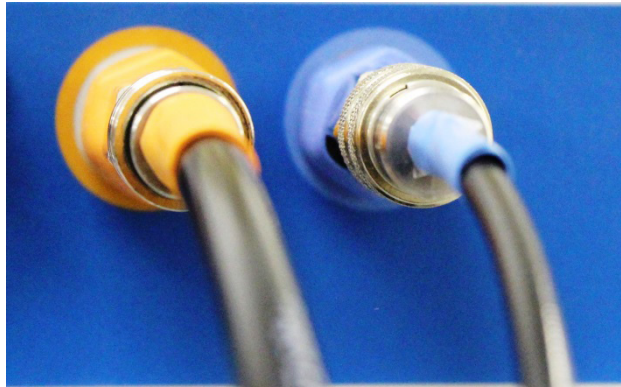

Figure 13: Color Coded Pneumatic Connectors

4. Ensure each pneumatic connection is fully seated by listening for an audible “click” as each connector engages its receptacle. Gently tug on each tube to ensure proper engagement with connector.
5. Insert the corresponding red and black colored connections into the thermocouple connectors, see Figure 15.



Figure 14

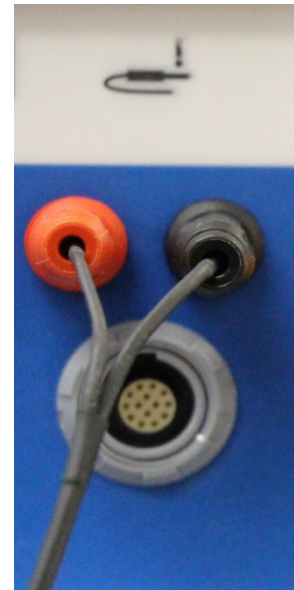

Figure 15

6. The cryoICE probe icon, seen above in Figure 14, will extinguish if the cryoICE probe is functioning properly and the approximate room temperature will be displayed on the temperature display (typically 10 to 25° C). An example of this is shown in Figure 16.



Figure 16: Probe Temperature Display

7. A test run is advised to ensure the cryoICE probe and system is working properly prior to the case.
8. Pneumatic connectors should only be unplugged when the cryoICE BOX is in the READY mode.

Set Ablation Time

1. The time of ablation is displayed in the middle of the interface of the cryoICE BOX and is indicated by a clock underneath the display. The display shows the time of ablation in seconds, see Figure 17.



Figure 17: Ablation Time Display

2. To change the duration of the ablation, press either of the up or down arrows to the right of the time display. The display will change in increments of ten seconds. The timer will reset to the default setting after a single cycle has been run.

Start Ablation

1. Ensure cryoICE BOX is powered on and the cryoICE probe and N2O is connected properly.
2. Check that desired ablation time is displayed, change if needed.
3. Press and release the Activation Button at the left of the device to begin the ablation.
4. The temperature display on the front panel displays the cryoICE probe temperature. A double-beep will indicate that the therapeutic temperature has been reached (typically -40°C), and the ablation timer will begin to count down. A short beep will sound every 30 seconds. A series of beeps will indicate the last 5-seconds of the Ablation cycle.
5. At the conclusion of the Ablation cycle, the cryoICE BOX will automatically transition into the DEFROST mode. The DEFROST indicator will illuminate indicating probe warming until it has reached the transition temperature which ends DEFROST, then the unit will automatically transition into READY and vent the probe. During the DEFROST cycle, a triple-beep will alert the user that the temperature of the probe has transitioned above 0°C degrees.

5. SPECIAL CASES

Abort FREEZE

To stop ablation during a FREEZE cycle, press and release the Activation Button during the ablation. The system will then transition into DEFROST mode.

Change Ablation Time during Ablation

To change the current ablation time, the up and down arrows can be used to add or decrease time in 10 second increments.

Emergency Stop

To stop ablation and depressurize the cryoICE probe during a FREEZE or DEFROST push the Activation Button to vent cryoICE probe until the cryoICE BOX system has sequenced into READY mode.

The unit can also be stopped by turning off power in the back of the unit or unplugging it from the AC power outlet. The flow of N2O will stop, however gas will be trapped within the cryoICE probe and the cryoICE BOX. This gas will be vented the next time the cryoICE BOX is powered on.

Set Default Ablation Time

1. Ensure cryoICE BOX is powered on.
2. Press and hold both up and down arrows simultaneously for one second to initiate the mode that allows a change to the default ablation time.

3. The time display will flash and the default time can now be changed by using the up or down arrows. The time will change in increments of 10 seconds. The time cannot be set lower than 20 seconds, nor higher than 270 seconds.
4. To save the set default time, the display will stop flashing after 5 seconds and the new default will be set.

Operate Without Temperature Reading

If the cryoICE BOX does not display a temperature and the cryoICE probe is properly plugged in (red and black connectors) the cryoICE probe should not be used. If the Activation Button is pressed with this condition, the cryoICE BOX will flash and beep for 5-seconds. If the Activation Button is pressed again within 5-seconds, the cryoICE BOX will sequence into FREEZE mode and the counter will start the countdown immediately. This should only be done at the discretion of a physician as there will not be temperature feedback.

6. SYSTEM DISASSEMBLY AFTER USE

Check to see that the service icon is not illuminated. If so, notify AtriCure service to correct the problem.

Disconnecting the AtriCure cryoICE Probe

1. The cryoICE probe can only be removed in the READY mode.
2. Remove the cryoICE probes pneumatic connections by pushing in the sliding ring on the receptacle while pulling out the cryoICE probe side of the connector.
3. Remove the black and red connections for the thermocouples.

N₂O Cylinder Removal

1. Turn-Off the N2O cylinder by turning the knob clockwise.
2. Purge the N2O from the system by pressing and holding the N2O Exhaust Switch in the back of the unit. Watch the pressure gauge on the cylinder to see that all the pressure has been released. If the cryoICE BOX is powered off, pull and hold the N2O Manual Exhaust Knob until the pressure is relieved.
3. Disconnect the gas cylinder inlet fitting on the back of the cryoICE BOX by sliding the collar back.
4. Disconnect the hose from the N2O cylinder by unscrewing the black knob.
5. Turn-Off power and unplug the cryoICE BOX.

7. PREVENTIVE MAINTENANCE AND CLEANING OF THE AtriCure cryoICE BOX

Cleaning and Disinfecting Instructions

Note: Do not spray or pour liquids directly on the unit.

Note: The unit and/or accessories cannot be sterilized.



WARNING



Ensure Isopropyl Alcohol (IPA) is completely dry before operating the unit.



CAUTION: Avoid caustic or abrasive cleaners to avoid damage to ACM chassis.

Guidelines

The following guidelines are recommended for cleaning the unit. It is the user's responsibility to qualify any deviations from these processing methods.

1. Disconnect the unit or cart from the outlet before cleaning.
2. If the unit and/or accessories are contaminated with blood or other body fluids, they shall be cleaned before the contamination can dry (within two hours of contamination).
3. The outer surfaces of the unit and/or accessories shall be cleaned with 70% -90% Isopropyl alcohol (IPA) wipes for a minimum of two minutes. Do not allow fluids to enter the chassis.
4. Pay attention to all areas where fluids or soil may gather, such as under/ around the handles or any tight crevices/ grooves.
5. Dry the unit and/or accessories with a dry, white lint-free cloth.
6. Conduct a final confirmation of the cleaning process by visually inspecting the white cloth for remaining soil.
7. If soil remains on the white cloth, repeat steps 3 through 6.
8. After cleaning is complete, turn the unit on to perform Power On Self-Test (POST). If any errors are received, contact AtriCure to begin return process.

Preventive Maintenance

AtriCure service representatives or the hospital biomed personnel shall conduct annual preventative maintenance procedures to ensure all cryoICE BOX components are functioning as defined within this manual. Pay particular attention to operational and safety features, including but not limited to:

- Electrical power cords for fraying, damage, and proper grounding
- AC power switch
- Any front panel display damage including switches, numeric displays and indicator lights.
- cryoICE probe electronic interface connector damage, cracking or inability to insert and latch cryoICE probe connector.
- cryoICE probe pneumatic interface connector damage or inability to insert and latch cryoICE probe pneumatic connector.
- Carrying handle damage or inability to fold.
- Rubber feet damage, cracking or inability for the cryoICE BOX to remain stable on a flat surface.
- Rubber alignment cup damage, cracking or inability for the ASB/ASU to remain stable atop cryoICE BOX and within the alignment cup.
- Listen for leaks when pressurized.
- Other medical equipment that may be used simultaneously with the cryoICE BOX should also be inspected for damage. Specifically, check for insulation damage of electrical cables and associated connectors.

The cryoICE BOX does not have any customer serviceable parts aside from mains fuses and gas line desiccant filter for cryoICE BOX units so equipped. For servicing issues, contact AtriCure, Inc. at:

AtriCure Address / Toll Free Telephone Number

AtriCure, Inc.
7555 Innovation Way,
Mason, Ohio 45040 USA
1.866.349.2342

Corporate Website

www.atricure.com

Customer Service/ Product Inquiries

Telephone: 513-755-4100
866-349-2342 Toll Free
Fax: 513-755-4567

Replacement of AC Line Fuses

Tools and Parts

- Needle Nose Pliers

Fuses

AtriCure cryoICE BOX Model	Fuse Type	Manufacturer	Part Number
ACM1	T 4A L 250V	Schurter	0034.5049
ACM2	T 2A L 250V	Schurter	0034.5046

The cryoICE BOX unit has been pre-set at the factory to a nominal voltage of 115V (ACM1) or 230V (ACM2). The Rating Label below the Power Entry Module on the back panel of the cryoICE BOX indicates the selected Input Voltage for this unit. This setting should only be adjusted by the manufacturer or by an authorized AtriCure technical service representative.

Note: cryoICE BOX unit should be powered off and unplugged before continuing with the fuse replacement procedure.

Procedure to Replace AC Mains Fuses

1. Determine the fuse type by looking at the cryoICE BOX Model Number or the cryoICE BOX Rating Label.

- Using the needle nose pliers, carefully extract the fuse box from the power entry module by squeezing down on the fuse box tabs in the slots as shown in Figure 18.

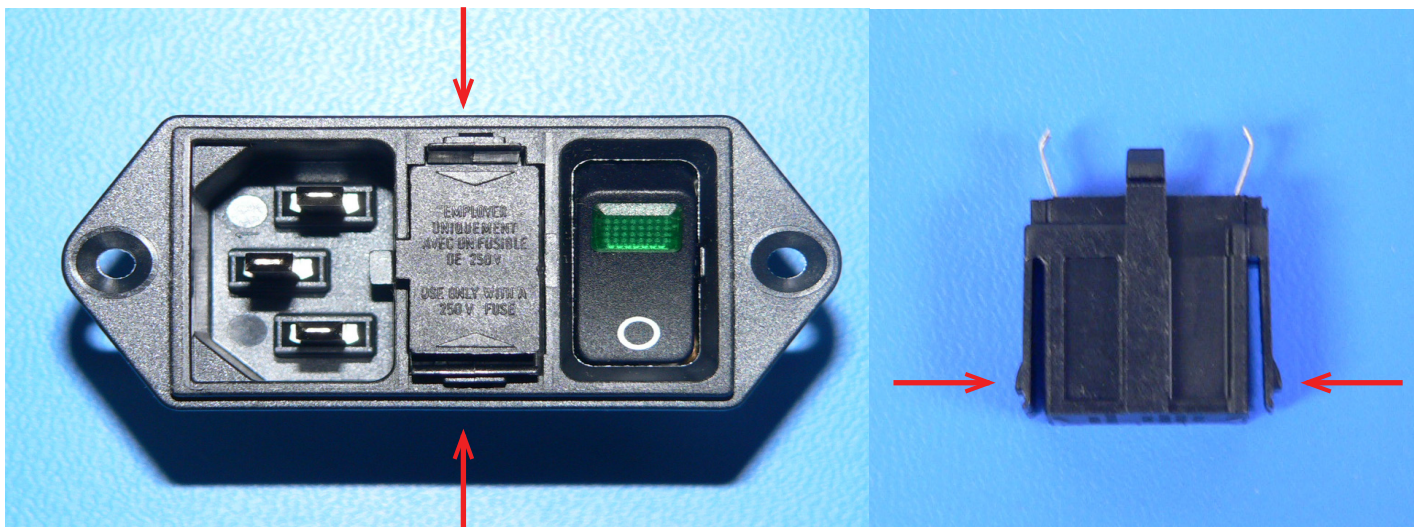

Figure 18: Fuse Box Tabs

- Replace the (2) two fuses located in the fuse box. Make sure the fuses are aligned properly.

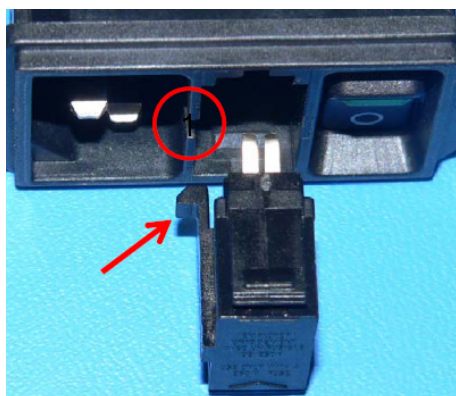

Figure 19: Guide Tab Location

- Align the fuse cartridge so the guide tab is towards the power entry side.
- Return the fuse box to the power entry module and push in firmly.
- Confirm operational status by plugging in the *cryoICE* BOX and turning power on. Ensure that the self-test is completed without errors.

Tank Hose Assembly without canisters – Standard

New AtriCure cryoICE BOX Installation

A001053	Packaged, ACM Accessories- Domestic
A001054	Packaged, ACM Accessories- International

Existing AtriCure cryoICE BOX Upgrade

A001056	Packaged, Gas Line Hose Module Assembly- Domestic
A001055	Packaged, Tank Hose Assembly- International

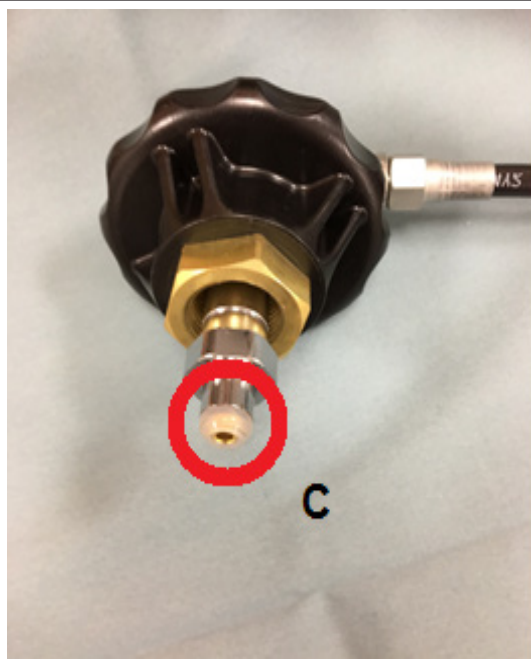

Figure 20: N₂O Cylinder Interface

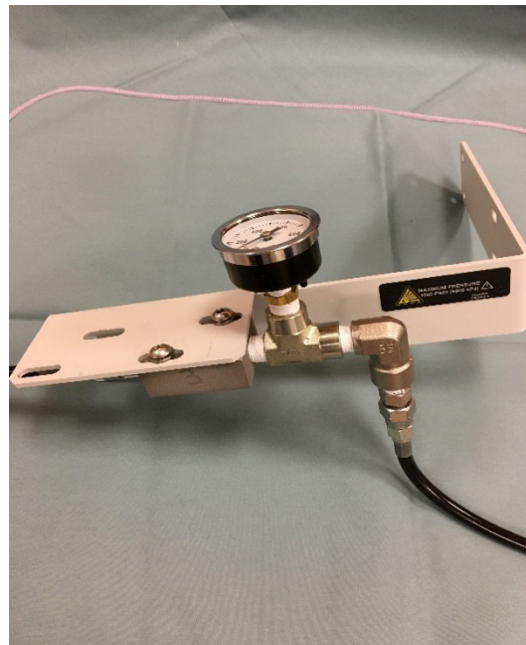

Figure 21: AtriCure cryoICE BOX Tank Hose Assembly without canisters

Replacement Part

Component "C"	Tip Washer	AtriCure	F021837
---------------	------------	----------	---------

Tank Hose Assembly with canisters – Alternate (Replacement of Desiccant Filter)

This section only applies to cryoICE Box Systems equipped with the Tank Hose Assembly which contains the canister set.

Tank Hose Assembly with Canisters Replacement Parts

Item	Supplied By	Part Number
Filter Cartridge	AtriCure	F021720
Filter O-ring	AtriCure	F010924
Tip Washer	AtriCure	F021837
O-Ring Lubricant	AtriCure	C002502

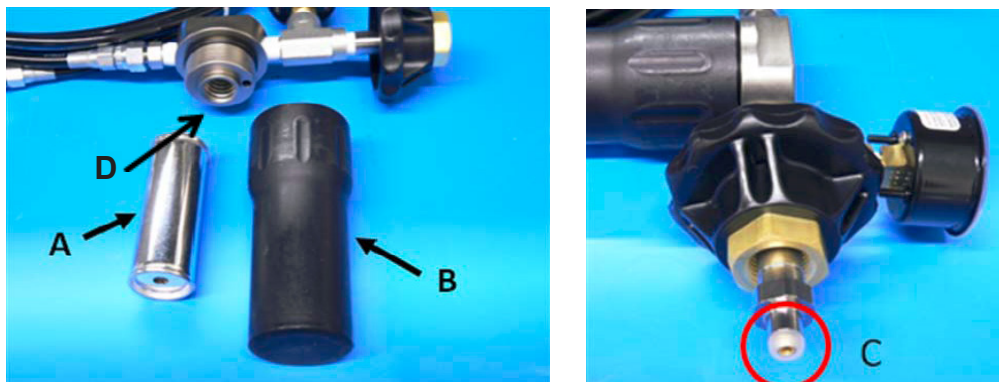

Figure 22: Gas Line Components

- Desiccant Filter Cartridge (A)

Note: Replace desiccant filter cartridge every time the N₂O tank is replaced.

- Filter Housing (B)
- Tip Washer (C)
- Filter O-Ring (D)

Note: Replace filter O-Ring with replacement of the desiccant filter cartridge.

Procedure

1. Prior to changing the Desiccant Filter Cartridge, assure that the *cryoICE* probe is disconnected from the patient and the *cryoICE* Box is turned off.
2. Unscrew the filter cartridge housing by rotating it counter-clockwise. Refer to Figure 23 below.



Figure 23: Filter Housing Removal

3. Remove the desiccant filter cartridge by rotating it counter-clockwise using hand force only. Refer to Figure 24 below.

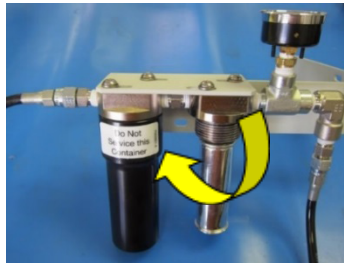

Figure 24: Desiccant Filter Cartridge Removal

4. Remove the old black O-ring from the top of the filter housing fixture.
5. Slide the new O-ring onto the filter housing fixture, making sure that it is fully seated in the groove at the top.
6. Apply a thin film of O-Ring Lubricant around the new O-Ring.
7. Replace the desiccant filter cartridge with the new cartridge.
8. Replace the filter housing by screwing on clockwise using hand force only.
9. Remove the old Tip Washer and replace it with the new washer.

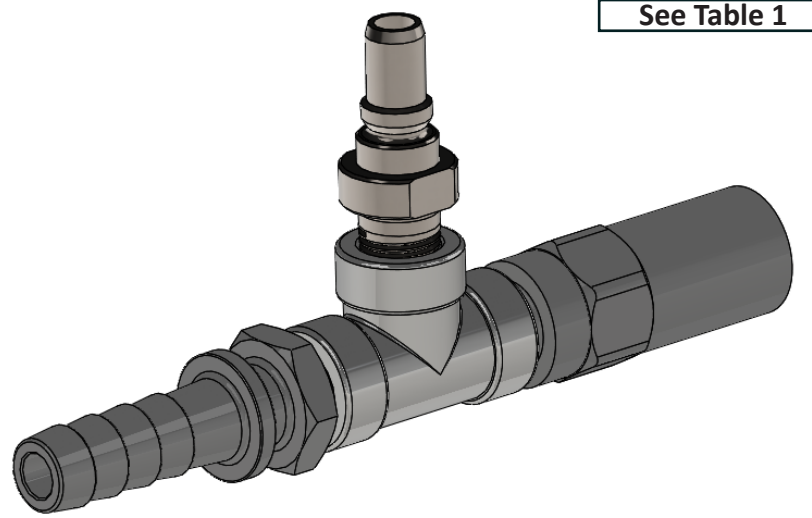

Figure 25: Exhaust Hose Connector Assembly – A001150

Table 1 – Region Specific Vacuum/WAGD Connectors

Connector	Part Description	Region
A001150-1	Medical Vacuum Connector DISS by 1/4" MNPT	US
A001150-2	Medical Vacuum Connector Chemetron by 1/4" MNPT	US
A001150-3	Medical Vacuum Connector PB by 1/4" MNPT	US
A001150-4	Medical Vacuum Connector Ohmeda by 1/4" MNPT	US
A001150-5	WAGD Connector DISS by 1/4" MNPT	US
A001150-6	WAGD Connector Chemetron by 1/4" MNPT	US
A001150-7	WAGD Connector PB by 1/4" MNPT	US
A001150-8	WAGD Connector Ohmeda by 1/4" MNPT	US
A001150-9	Japanese Type K Coupler to .250-18 NPT	JPN
A001150-10	Japanese Type C Coupler to .250-18 NPT	JPN
A001150-13	AGSS Type 1L Coupler to .250-18 NPT	EU
A001150-14	AGSS Alternate Coupler Assembly	EU



Other Detachable and Accessory Devices





Item	Supplied By	USA Part Number	International Part Number
ACM Footswitch	AtriCure	A000708	A000708
Tank Hose Assembly with canisters	AtriCure	A000837	A000838
Tank Hose Assembly without canisters	AtriCure	A001056	A001055
Heater Band Extension Springs (Qty. 6)	AtriCure	A000836	A000836
N ₂ O Exhaust Hose (50ft./15.2m.)	AtriCure	C002051	C002051
Cylinder Heater Band (CMH15)	AtriCure	A000728	A000728
	International Watlow	120150509 or SK025877-DWG7	120150509 or SK025877-DWG7
Cylinder Heater Band (CMH22)	AtriCure	A000727	A000727
	Domestic Watlow	120220507 or SK025877- DWG10	120220507 or SK025877-DWG10
AC Power Cord	AtriCure	C000262 125 VAC, 10A. (10ft./3.0m.)	C002090 (Continental EU) C003914 (AU) 250 VAC, 10A. (10ft./3.0m minimum)

Disposal

The cryoICE BOX does not contain hazardous substances. Follow local governing ordinances and recycling plans regarding disposal or recycling of device components. The used cryoICE probe is considered bio-hazardous. Follow facility procedures for disposal.

8. TROUBLESHOOTING

Problem	Possible Cause	Action
Front displays not lit.	<ul style="list-style-type: none"> • No power. • <i>cryoICE</i> BOX electrical failure. 	<ul style="list-style-type: none"> • Check power switch on back of <i>cryoICE</i> BOX. • Check plug connection on back of <i>cryoICE</i> BOX. • Check AC plug in wall socket. • Ensure power is available at wall socket. • Call AtriCure Service.
Cylinder Heater Band Icon Illuminated. 	<ul style="list-style-type: none"> • Heater not plugged in. • N₂O cylinder valve closed. • Empty N₂O cylinder. • Extremely cold N₂O cylinder. • Heater not attached to N₂O cylinder. • Heater malfunctioning. 	<ul style="list-style-type: none"> • Check connection on back of unit. • Ensure N₂O valve is open. • Replace N₂O cylinder. • Allow 15 minutes to warm up. • Attach Heater Band to cylinder. • Call AtriCure Service.
Temperature Not Displayed. 	<ul style="list-style-type: none"> • <i>cryoICE</i> probe not plugged in. • Malfunctioning <i>cryoICE</i> probe. • <i>cryoICE</i> BOX malfunctioning. 	<ul style="list-style-type: none"> • Ensure <i>cryoICE</i> probe thermocouple leads are firmly seated within their receptacles. • Replace <i>cryoICE</i> probe. • Call AtriCure Service.
<i>cryoICE</i> BOX has power but will not go into FREEZE mode.	<ul style="list-style-type: none"> • <i>cryoICE</i> probe not plugged in. • N₂O cylinder empty. • N₂O cylinder valve closed. • Inlet Gas Connection not secure. 	<ul style="list-style-type: none"> • Plug in <i>cryoICE</i> probe. • Replace N₂O Cylinder. • Open cylinder valve. • Ensure Inlet Gas Connection is completely seated.

Problem	Possible Cause	Action
<p><i>cryoICE</i> probe not getting cold enough.</p>	<ul style="list-style-type: none"> • Heater Band not properly installed. • N₂O cylinder low or out of gas. • Exhaust filter is clogged. 	<ul style="list-style-type: none"> • Check heater installation and heater icon. • Replace N₂O cylinder. • Exhaust connector (orange) is frosting/freezing ice (liquid condensate is not uncommon) call AtriCure Service.
<p>Temperature Display indicates incorrect values.</p>	<ul style="list-style-type: none"> • <i>cryoICE</i> probe plugged in incorrectly. • Malfunctioning <i>cryoICE</i> probe. • Electromagnetic interference • <i>cryoICE</i> BOX malfunctioning. 	<ul style="list-style-type: none"> • Ensure <i>cryoICE</i> probe black and red plugs are in correct receptacles. • Replace <i>cryoICE</i> probe. • Relocate or Reorient <i>cryoICE</i> BOX • Call AtriCure Service.
<p>Bottom segment on N₂O icon flashing.</p> 	<ul style="list-style-type: none"> • N₂O cylinder empty. • N₂O cylinder cold. • Indicator not reset when cylinder was replaced. 	<ul style="list-style-type: none"> • Replace with full cylinder. • Make sure heater blanket is installed and working. Allow time for the cylinder to warm up if it is cold. • Press Reset when cylinder is replaced.
<p>N₂O Gas Gauge flashing.</p> 	<ul style="list-style-type: none"> • N₂O cylinder pressure is below 650psi. • N₂O cylinder empty. 	<ul style="list-style-type: none"> • Make sure heater blanket is installed and working. Allow time for the cylinder to warm up if it is cold. • Replace with full cylinder.
<p>Amber Low Pressure Indicator on N₂O icon flashing.</p> 	<ul style="list-style-type: none"> • N₂O cylinder not turned on. 	<ul style="list-style-type: none"> • Ensure the N₂O cylinder is fully turned on.
<p>Difficulty connecting a <i>cryoICE</i> probe to the <i>cryoICE</i> BOX.</p> 	<ul style="list-style-type: none"> • Trapped N₂O within the system. • Quick connector out of sequence, sleeve on blue connector is forward. • Quick connector O-ring dried out and/or swelling. 	<ul style="list-style-type: none"> • Power-On the <i>cryoICE</i> BOX which clears trapped gas exerting pressure on the connector. • Push the sleeve toward the <i>cryoICE</i> BOX until it locks back. (usually clicks) • Lubricate the connector inside with silicon-based O-ring lubrication such as AtriCure Part No. C002502.

Problem	Possible Cause	Action
<p>Wrench Icon flashing and clicking heard inside <i>cryoICE</i> BOX, may also include display flashing.</p> 	<ul style="list-style-type: none"> Heater band over temperature due to empty N₂O Cylinder. Heater band over temperature due to loose fit on N₂O cylinder. 	<ul style="list-style-type: none"> Unplug heater band if clicking stops and/ or display flashing stops, check if tank is warm to the touch – If so, tank is likely empty, replace tank with full tank. Power-off, then Power-on <i>cryoICE</i> BOX to reset wrench Icon. Heater band is to be tight and positioned at bottom of tank, cord at top edge. If problem is not corrected by above two actions, return <i>cryoICE</i> BOX and heater band to AtriCure.
<p><i>cryoICE</i> probe getting colder than -75°C and not defrosting.</p>	<ul style="list-style-type: none"> The <i>cryoICE</i> BOX and probe system are flooded with liquid N₂O. The N₂O quality is not adequate to be used as a refrigerant. N₂O cylinder contains a siphon tube or a dip tube. 	<ul style="list-style-type: none"> If probe does not reach desired defrost temperature, apply warm sterile saline to the tissue and probe area as necessary. Replace the Tank Hose Assembly which has canister set with Tank Hose Assembly without canister set. <p>A001056 – Domestic Tank Hose Assembly without canisters</p> <p>A001055 – International Tank Hose Assembly without canisters</p> <ul style="list-style-type: none"> Power-On <i>cryoICE</i> BOX within a few minutes of <i>cryoICE</i> probe use to minimize N₂O condensing in system. Medical grade nitrous oxide, 3ppm water maximum, is preferred for use with AtriCure cryogenic Devices. Verify the N₂O cylinder does not contain a siphon tube or dip tube. Cylinder valve body should be blank (no mark of: S, DT, or D.)

AtriCure *cryoICE* BOX Error Codes

If an error condition should occur, the Maintenance Needed Indicator or the System Fault Indicator will illuminate. The probe Temperature display on the front panel will temporarily display one of the following error codes during the power-up sequence. Contact AtriCure Service if one of these conditions occurs.

Error ID	Error	Likely Cause
001	No 24 VDC	Fuse (F2)
002	Cylinder Over Temperature	Heater blanket
003	probe Overpressure	Pressure regulator
004	Unwanted probe Pressure	Leaky inlet valve
005	No 230 VAC	Fuse (F1)
008	Cylinder Over Pressure/Temperature	Overheated Cylinder
PPP	Power On Self-Test Error	Activation Button/Footswitch Pressed during power up

9. ELECTROMAGNETIC COMPATABILITY TABLES

Electromagnetic Emissions

Guidance and manufacturer's declaration – Electromagnetic Emissions	
The AtriCure cryoICE BOX is intended for use in the electromagnetic environment specified below. The customer or the user of the AtriCure cryoICE BOX unit should assure that it is used in such an environment.	
Phenomenon	Professional healthcare facility environment ^{a)}
Conducted and radiated RF EMISSIONS	CISPR 11 (Group 1, Class A)
Harmonic distortion	See IEC 61000-3-2 ^{b)} (Class A)
Voltage fluctuations and flicker	IEC 61000-3-3 ^{b)}
a) Professional healthcare facility environment.	
b) This test is not applicable in this environment unless the AtriCure cryoICE BOX used there will be connected to the PUBLIC MAINS NETWORK and the power input is otherwise within the scope of the Basic EMC standard.	

Electromagnetic Immunity – Enclosure Port

Guidance and manufacturer's declaration – Enclosure Port Immunity		
The AtriCure cryoICE BOX is intended for use in the electromagnetic environment specified below. The customer or the user of the AtriCure cryoICE BOX unit should assure that it is used in such an environment.		
Phenomenon	Basic EMC standard or test method	Immunity Test Levels
		Professional healthcare facility environment
ELECTROSTATIC DISCHARGE	IEC 61000-4-2	± 8 kV contact ± 2kV, ± 4kV, ± 8kV, ± 15 kV air
Radiated RF EM fields ^{a)}	IEC 61000-4-3	3 V/m ^{f)} 80 MHz – 2.7 GHz ^{b)} 80% AM at 1kHz ^{c)}
Proximity fields from RF wireless communications equipment	IEC 61000-4-3	Refer to Table 9 in IEC 60601-1-2:2014 – Test specification for Enclosure Port Immunity to RF wireless communication equipment
Rated power frequency magnetic fields ^{d) e)}	IEC 61000-4-8	30 A/m ^{g)} 50 Hz or 60 Hz

a) The interface between the PATIENT physiological signal simulation, if used, and the AtriCure cryoICE BOX shall be located within 0.1 m of the vertical plane or the uniform field area in one orientation of the AtriCure cryoICE BOX.

b) ME EQUIPMENT and ME SYSTEMS that intentionally receive RF electromagnetic energy for its operation shall be tested at the frequency of reception. Testing may be performed at other modulation frequencies identified by the RISK MANAGEMENT PROCESS. This test assesses the BASIC SAFETY and ESSENTIAL PERFORMANCE of an intentional receiver when an ambient signal is in the passband. It is understood that the receiver might not achieve normal reception during the test.

c) Testing may be performed at other modulation frequencies identified by the RISK MANAGEMENT PROCESS.

d) Applies only to ME EQUIPMENT and ME SYSTEMS with magnetically sensitive components or circuitry.

e) During the test, the AtriCure cryoICE BOX may be powered at any NOMINAL input voltage, but with the same frequency as the test signal.

f) Before modulation is applied.

g) This test level assumes a minimum distance between the AtriCure cryoICE BOX and sources of power frequency magnetic field of at least 15 cm. If the RISK ANALYSIS shows that the AtriCure cryoICE BOX will be used closer than 15 cm to sources of power frequency magnetic field, the IMMUNITY TEST LEVEL shall be adjusted as appropriate for the minimum expected distance.

Electromagnetic Immunity – Input A.C. Power Port

Guidance and manufacturer's declaration – Input A.C Power Port Immunity		
The AtriCure cryoICE BOX is intended for use in the electromagnetic environment specified below. The customer or the user of the AtriCure cryoICE BOX unit should assure that it is used in such an environment.		
Phenomenon	Basic EMC standard or test method	Immunity Test Levels
		Professional healthcare facility environment
Electrical fast transients / bursts ^{a) l) o)}	IEC 61000-4-4	± 2 kV 100 kHz repetition frequency
Surges ^{a) b) j) o)} Line-to-line	IEC 61000-4-5	± 0.5 kV, ± 1 kV
Surges ^{a) b) j) k) o)} Line-to-ground	IEC 61000-4-5	± 0.5 kV, ± 1 kV, ± 2 kV
Conducted disturbances Induced by RF fields ^{c) d) o)}	IEC 61000-4-6	3 V/m ^{m)} 0.15 MHz - 80 MHz 6 V/m ^{m)} in ISM bands between 0.15 MHz and 80 MHz ⁿ⁾ 80% AM at 1kHz ^{e)}
Voltage dips ^{f) p) r)}	IEC 61000-4-11	0% U _T : 0.5 cycle ^{g)} At 0°, 45°, 90°, 135°, 180°, 225°, 270° and 315° ^{q)}
		0% U _T : 1 cycle And 70% U _T : 25/30 cycles ^{h)} Single phase: at 0°
Voltage interruptions ^{f) i) o) r)}	IEC 61000-4-11	0% U _T : 250/300 cycle ^{h)}

- a) The test may be performed at any one power input voltage within the AtriCure *cryoICE* BOX's RATED voltage range. If the AtriCure *cryoICE* BOX is tested at one power input voltage, It is not necessary to re-test at additional voltages.
- b) All AtriCure *cryoICE* BOX cables are attached during the test.
- c) Calibration for current injection clamps shall be performed in a 150 Ω system.
- d) If the frequency stepping skips over an ISM or amateur band, as applicable, an additional test frequency shall be used in the ISM or amateur radio band. This applies to each ISM and amateur radio band within the specified frequency range.
- e) Testing may be performed at other modulation frequencies identified by the RISK MANAGEMENT PROCESS.
- f) ME EQUIPMENT and ME SYSTEMS with a D.C. power input intended for use with A.C.-to-D.C. converters shall be tested using a converter that meets the specifications of the MANUFACTURER of the ME EQUIPMENT or ME SYSTEM. The IMMUNITY TEST LEVELS are applied to the A.C. power input of the converter.
- g) Applicable only to ME EQUIPMENT and ME SYSTEMS connected to single-phase A.C. mains.
- h) E.g. 10/12 means 10 periods at 50 Hz or 12 periods at 60 Hz.
- i) ME EQUIPMENT and ME SYSTEMS with RATED Input current greater than 16 A/phase shall be interrupted once for 250/300 cycles at any angle and at all phases at the same time (if applicable). ME EQUIPMENT and ME SYSTEMS with battery backup shall resume line power operation after the test. For ME EQUIPMENT and ME SYSTEMS with RATED input current not exceeding 16 A, all phases shall be interrupted simultaneously.
- j) ME EQUIPMENT and ME SYSTEMS that do not have a surge protection device in the primary power circuit may be tested only at ± 2 kV line(s) to earth and ± 1 kV line(s) to line(s).
- k) Not applicable to CLASS 11 ME EQUIPMENT and ME SYSTEMS.
- l) Direct coupling shall be used.
- m) R.M.S., before modulation is applied.
- n) The ISM (Industrial, scientific and medical) bands between 0.15 MHz and 80 MHz are 6.765 MHz to 6.795 MHz; 13.553 MHz to 13.567 MHz; 26.957 MHz to 27.283 MHz; and 40.66 MHz to 40.70 MHz The amateur radio bands between 0.15 MHz and 80 MHz are 1.8 MHz to 2.0 MHz, 3.5 MHz to 4.0 MHz, 5.3 MHz to 5.4 MHz, 7 MHz to 7.3 MHz, 10.1 MHz to 10.15 MHz, 14 MHz to 14.2 MHz, 18.07 MHz to 18.17 MHz, 21.0 MHz to 21.4 MHz, 24.89 MHz to 24.99 MHz, 28.0 MHz to 29.7 MHz and 50.0 MHz to 54.0 MHz.
- o) Applicable to ME EQUIPMENT and ME SYSTEMS with RATED input current less than or equal to 16 A/phase and ME EQUIPMENT and ME SYSTEMS with RATED Input current greater than 16 A/phase.
- p) Applicable to ME EQUIPMENT and ME SYSTEMS with RATED Input current less than or equal to 16 A/ phase.
- q) At some phase angles, applying this test to ME EQUIPMENT with transformer mains power Input might cause an overcurrent protection device to open. This can occur due to magnetic flux saturation of the transformer core after the voltage dip. If this occurs, the AtriCure *cryoICE* BOX shall provide BASIC SAFETY during and after the test.
- r) For ME EQUIPMENT and ME SYSTEMS that have multiple voltage settings or auto ranging voltage capability, the test shall be performed at the minimum and maximum RATED input voltage. ME EQUIPMENT and ME SYSTEMS with a RATED input voltage range of less than 25 % of the highest RATED input voltage shall be tested at one RATED input voltage within the range.

Electromagnetic Immunity – Input D.C. Power Port – Not Applicable

Electromagnetic Immunity – Patient Coupling Port

Guidance and manufacturer's declaration – Patient Coupling Port Immunity		
The AtriCure cryoICE BOX is intended for use in the electromagnetic environment specified below. The customer or the user of the AtriCure cryoICE BOX unit should assure that it is used in such an environment.		
Phenomenon	Basic EMC standard or test method	Immunity Test Levels
		Professional healthcare facility environment
ELECTROSTATIC DISCHARGE ^{c)}	IEC 61000-4-2	± 8 kV contact ± 2kV, ± 4kV, ± 8kV, ± 15 kV air
Conducted disturbances induced by RF fields ^{a)}	IEC 61000-4-6	3 V ^{b)} 0.15 MHz - 80 MHz 6V ^{b)} in ISM bands between 0.15 MHz and 80 MHz 80% AM at 1 kHz
<p>a) The following apply:</p> <ul style="list-style-type: none"> - All PATIENT-COUPLED cables shall be tested, either Individually or bundled - PATIENT-COUPLED cables shall be tested using a current clamp unless a current clamp is not suitable. In cases where a current clamp is not suitable, an EM clamp shall be used. - No intentional decoupling device shall be used between the injection point and the PATIENT COUPLING POINT in any case. - Testing may be performed at other modulation frequencies identified by the RISK MANAGEMENT PROCESS. - Tubes that are intentionally filled with conductive liquids end intended to be connected to a PATIENT shall be considered to be PATIENT-COUPLED cables. - If the frequency stepping skips over an ISM or amateur radio band, as applicable, an additional test frequency shall be used in the ISM or amateur radio band. This applies to each ISM and amateur radio band within the specified frequency range. - The ISM (Industrial, scientific and medical) bands between 0.15 MHz and 80 MHz are 6.765 MHz to 6.795 MHz; 13.553 MHz to 13.567 MHz; 26.957 MHz to 27.283 MHz; and 40.66 MHz to 40.70 MHz. The amateur radio bands between 0.15 MHz and 80 MHz are 1.8 MHz to 2.0 MHz, 3.5 MHz to 4.0 MHz, 5.3 MHz to 5.4 MHz, 7 MHz to 7.3 MHz, 10.1 MHz to 10.15 MHz, 14 MHz to 14.2 MHz, 18.07 MHz to 18.17 MHz, 21.0 MHz to 21.4 MHz, 24.89 MHz to 24.99 MHz, 28.0 MHz to 29.7 MHz and 50.0 MHz to 54.0 MHz. <p>b) R.M.S., before modulation is applied</p> <p>c) Discharges shall be applied with no connection to an artificial hand and no connection to PATIENT simulation. PATIENT simulation may be connected after the test as needed in order to verify BASIC SAFETY and ESSENTIAL PERFORMANCE.</p>		

Warranties

Limitation on Liability

This warranty and the rights and obligations hereunder shall be construed under and governed by the laws of the State of Ohio, U.S.A.

AtriCure, Inc. warrants this product to be free from defects in material and workmanship under normal use and preventive maintenance for the respective warranty period shown below. AtriCure's obligation under this warranty is limited to the repair or replacement, at its option, of any product, or part thereof, which has been returned to AtriCure, Inc. or its Distributor within the applicable time period shown below and which examination disclosed, to AtriCure's satisfaction, to be defective. This warranty does not apply to any product, or part thereof, that has been: (1) adversely affected due to use with devices manufactured or distributed by parties not authorized by AtriCure, Inc. (2) repaired or altered outside AtriCure's factory in a way so as to, in AtriCure's judgment, affect its stability or reliability, (3) subjected to improper use, negligence or accident, or (4) used other than in accordance with the design and use parameters, instructions and guidelines for the product or with functional, operational or environmental standards for similar products generally accepted in the industry. **AtriCure has no control over the operation, inspection, maintenance or use of its products after sale, lease or transfer, and has no control of the selection of Customer's patients.**

AtriCure's products are warranted for the following periods after shipment to the original purchaser:

AtriCure cryoICE BOX Unit	One (1) Year
AtriCure Cylinder Heater Band	One (1) Year
AtriCure Gas Line Hose Assembly.....	One (1) Year
Grounded Electrical Cord	One (1) Year
AtriCure Cryo Footswitch	One (1) Year

THIS WARRANTY IS IN LIEU OF ALL OTHER WARRANTIES, EXPRESS OR IMPLIED, INCLUDING THE WARRANTIES OR MERCHANTABILITY AND FITNESS FOR A PARTICULAR PURPOSE, AND OF ALL OTHER OBLIGATIONS OR LIABILITIES ON THE PART OF ATRICURE, INC. AND IS A PURCHASER'S EXCLUSIVE REMEDY. IN NO EVENT SHALL ATRICURE, INC. BE LIABLE FOR SPECIAL, INCIDENTAL OR CONSEQUENTIAL DAMAGES INCLUDING, WITHOUT LIMITATION, DAMAGES RESULTING FROM LOSS OF USE, PROFITS, BUSINESS OR GOODWILL.

AtriCure, Inc. neither assumes nor authorizes any other person to assume for it any other liability in connection with the sale or use of any of AtriCure Inc. products. There are no warranties that extend beyond the terms presented unless an extended warranty is purchased before the original warranty expires. **No agent, employee or representative of AtriCure has any authority to change any of the foregoing or assume or bind AtriCure to any additional liability or responsibility.** AtriCure, Inc. reserves the right to make changes to products built and/or sold by them at any time without incurring any obligation to make the same or similar changes on products previously built and/or sold by them.

Disclaimer

Users assume responsibility for approving the acceptable condition of this product before it is used, and for ensuring that the product is only used in the manner described in these instructions for use. Under no circumstances will AtriCure, Inc. be responsible for any incidental, special or consequential loss, damage, or expense, which is the result of the deliberate misuse of this product, including any loss, damage, or expense which is related to personal injury or damage to property.

(This page is intentionally left blank)

(This page is intentionally left blank)